



Ceiling diffuser  
**MSA**



# Maintenance and installation guide



**KEEP THIS GUIDE**

# nadklima.com

**Québec**

**NAD Klima (head office)**

144 Léger, Sherbrooke (Qué) J1L 1L9

(819) 780-0111

1 866 531-1739

info@nadklima.com

**Ontario**

**NAD Klima Ontario**

2840 Argentia Road, Unit 6

Mississauga (Ontario) L5N 8G4

416 860-1067

ontario@nadklima.com

## CONFIGURATION

Whether on a square or rectangular plate, slots receiving the eccentric rollers are laid out in a parallel pattern.

The diffuser is mounted on a plenum.

The frontal plate is attached with screws distributed over the periphery of the frontal plate..

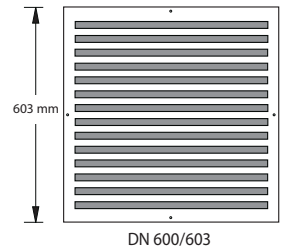
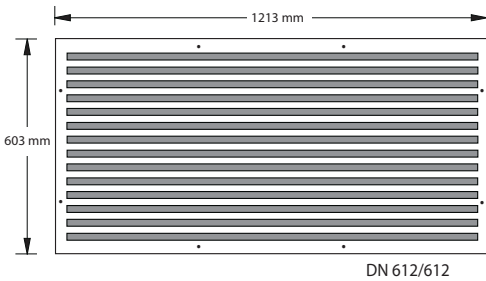
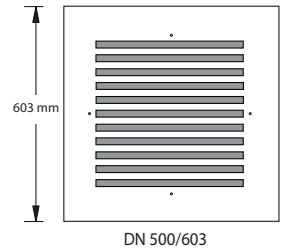
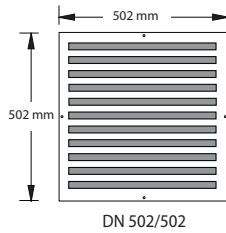
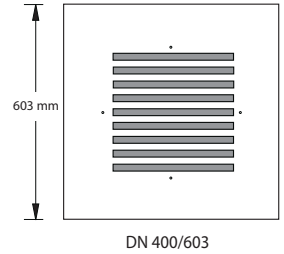
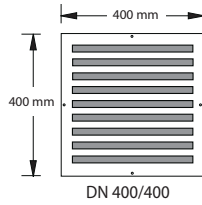
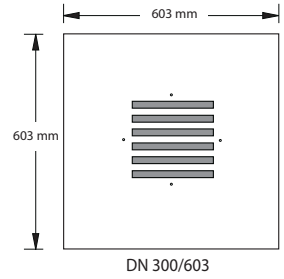
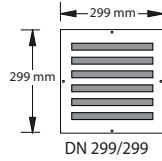

## Mode of operation

The 100 mm long eccentric rollers can be rotated 360 degrees. In standard position (21), the eccentric roller establish, through the profile of the slots, a streamline in which air is carried along.

At the roller's outlet, a low pressure is created, generating a high rate of induction.

## Controlling air flow direction

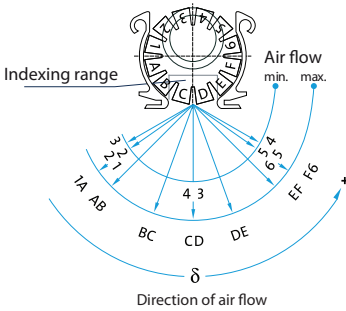

### Roller position 1A

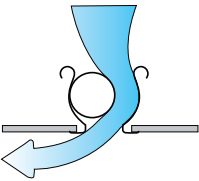

### Roller position 21

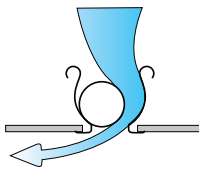

### Roller position 43

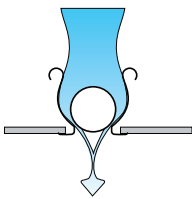

### Roller position cd

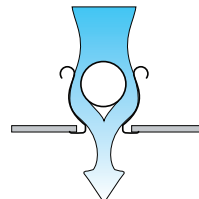

## Air flow

**Flow on 1 side (DVD)**  
position 21 or 65.

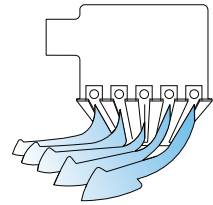

**Divergent flow (DVS)**  
position 21 or 65

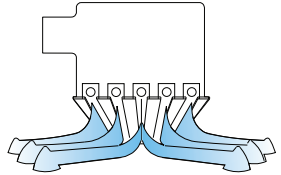

**Diffuse flow (DFS)**  
alternately to 21 and 65

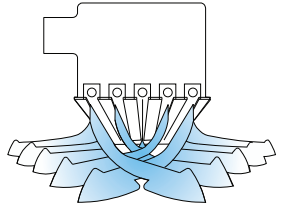

**Vertical flow-Long reaching (DVL)**  
position : central slots on CD  
others in positions 1A and F6.

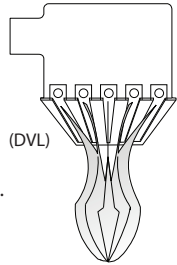

**Vertical flow (DVV)**  
position CD

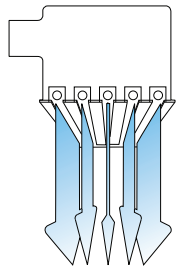

## DIMENSIONS

### Regular plenum

#### Side inlet

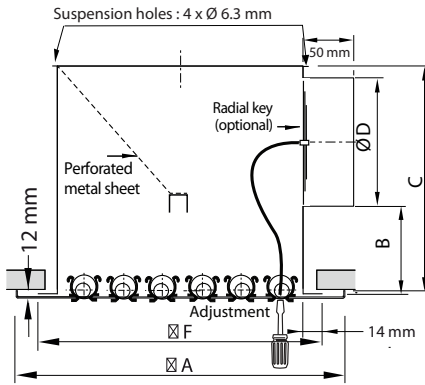

#### Top inlet

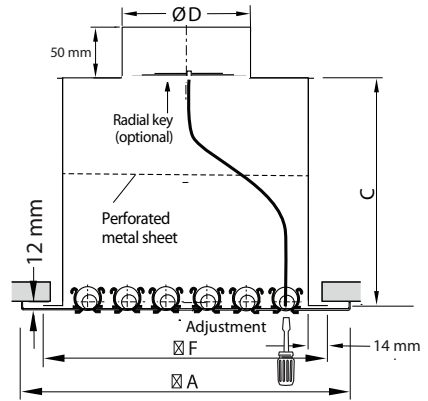

### Regular plenum

DN	300	400	500	600	612
Size A	299	400	502	603	603/1213
Size B	75	75	82	40	50
Size C	251	251	312	364	418
Size ØD	150	150	200	300	350
Size F	296	399	490	590	590/1195
No. slots	6	9	11	14	14
Weight (kg)	4.6	5.6	8.6	12.2	27.4

### Table for the opening in the gypsum (mm)

DN	300	400	500	600	612
Wide	282	385	476	576	576
Lenght	282	385	476	576	1181

## DIMENSIONS

### Plenum with fire-resistant damper

Classified ULC (Underwriters laboratories of Canada), the NAD Klima diffusers with fire resistant dampers have a fire-resistant rating of 3 hours.

The fire-resistant damper is integrated directly to the plenum. This assembly is designed for installation in either a suspended or gypsum ceiling

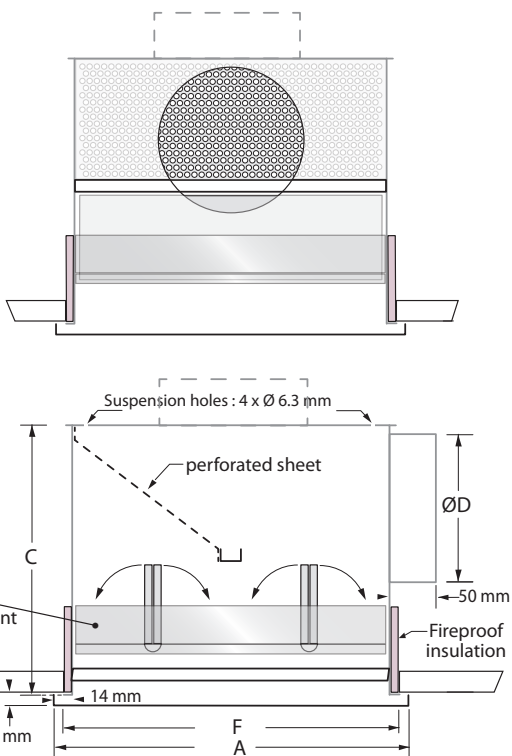

**LISTED**  
Air Terminal Unit - R38924  
CAN/ULC - S112.2 et CAN/ULC - S101



**CLASSIFIED**  
CEILING AIR DIFFUSER  
FIRE RESISTANCE CLASSIFICATION  
ANSI/UL 555C et ANSI/UL 263

DN	600	612
Size A	603	603/1213
Size B	40	50
Size C	515	569
Size ØD	300	350
Size F	590	590/1195
No. slots	14	14
Weight (kg)	20.2	40.4

**Table for opening in the gypsum (mm)**

DN	600	612
Wide	576	576
Length	576	1181

**Note :**  
**Balancing damper is not available with a fire-resistant damper.**

## INSTALLATION IN A GYPSUM CEILING

### MSA

#### A) Opening in the gypsum

Choose one of the three (3) options installation shown at right.

##### Option 1

- Measure the diffuser's dimensions
- REMOVE 13 mm or (1/2 inch)
- Cut a square in the gypsum corresponding to these measures (dimension of diffuser - 13 mm)
- Around this hole, insert a plaster frame and fix it

##### Option 2 and 3

- Measure the diffuser's dimensions
- ADD 13 mm (1/2") to the width and 13 mm (1/2") to the length
- Cut the gypsum corresponding to these measures (dimension of diffuser + 13 mm)
- Around this hole, insert a plaster frame and fix it.

#### B) Install the plenum box

The plenum will be suspended with metal wire through suspension's holes (4) predrilled for this purpose.

As shown in the drawing on the right, install the plenum by adjusting its height.

According to the **option 1**, the base of plenum should be 3 mm (1/8") under the ceiling, outside the gypsum's hole with option 3, the base of the plenum will press outside the gypsum's hole.

#### C) Install the diffuser

Fix the diffuser using the anchor screw provided for this purpose on the edge of plenum.

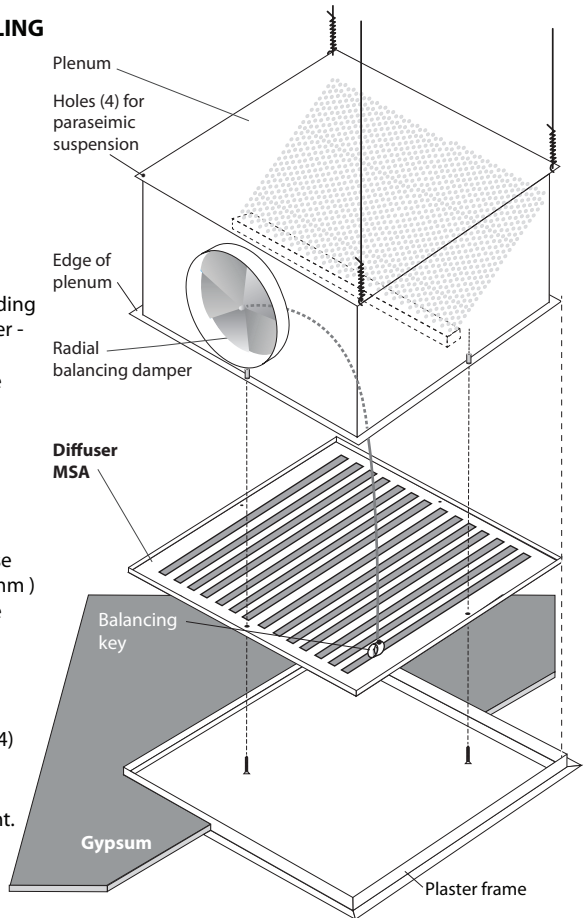

**Option 1**  
diffuser under the ceiling

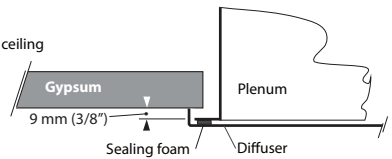

**Option 2**  
diffuser on frame

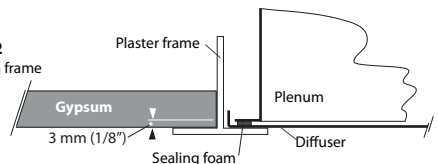

**Option 3**  
diffuser flush with the ceiling

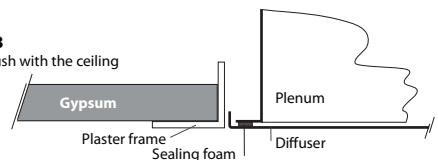

## INSTALLATION IN SUSPENDING CEILING

### MSA

#### A) Traverses du plafond suspendu

Make sure that the grid moldings of the suspended ceiling match the diffuser's face dimensions.

Also, make sure that the moldings of the ceiling are firmly anchored.

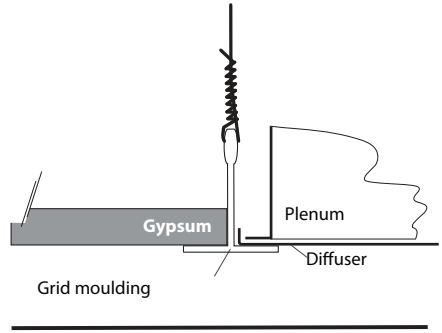

#### B) Install the diffuser to the plenum box

Place the diffuser on the plenum and, using the screw anchors provided for this purpose, fix the diffuser in the edge of the plenum.

#### C) Install the plenum and the diffuser

Slowly move and place the diffuser and plenum box in the ceiling space.

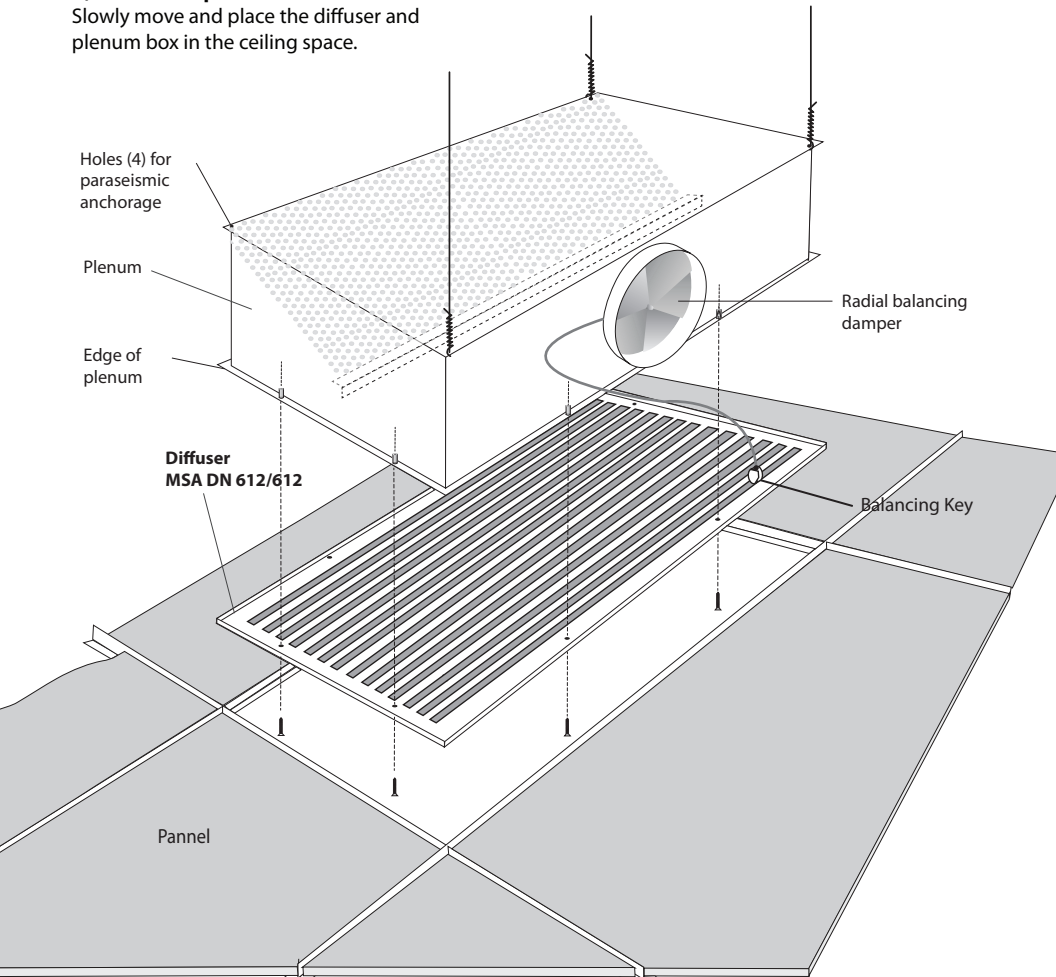

## MAINTENANCE



The diffuser DAL 358 from NAD Klima requires no special maintenance other than periodic cleaning.

We recommend cleaning the diffuser with a multi-filament brush or duster microfiber that you will pass softly on the diffuser. It has thermo-lacquered finish for an easy cleaning, as dust does not stick to it.

When cleaning, gently move the brush or duster in the direction of the rollers, so as not to change their adjustment.

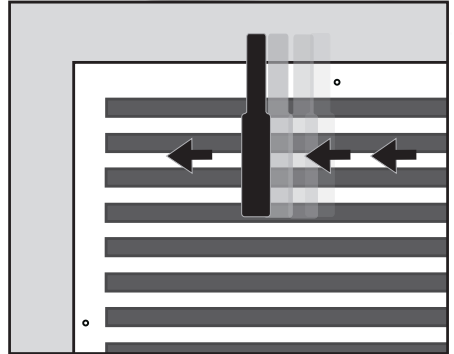

NAD Klima diffusers are the result of a manufacturing process in which our experts successfully meet your requirements and particular challenges.

Our range of equipment comprises the latest technological innovations. Our passion for work well done and digital precision ensure that the resulting product will guarantee the highest standards.

Manufactured in Sherbrooke, Quebec, (Canada) and distributed all across North America, our products raise the bar in terms of standards of quality, efficiency and energy savings.

A leader in air diffusers for LEED projects, NAD Klima is always striving to provide better comfort to consumers.

NAD Klima all products are the pride of an inventive, innovative and devoted team.

Our goal is not only to supply diffusers, but to create outstanding results.

We are NAD Klima.

