

WKD 381

Industrial diffuserl

catalog 1.1.6





WKD 381

Table of content

Description and benefits	1
Configuration and mode of operation	2
Range of application and quick selection	3
Performance diagrams	4
Temperature and induction behavior	8
Dimensions and weight	8
Specifications	9
Codification	9

Presentation and benefits

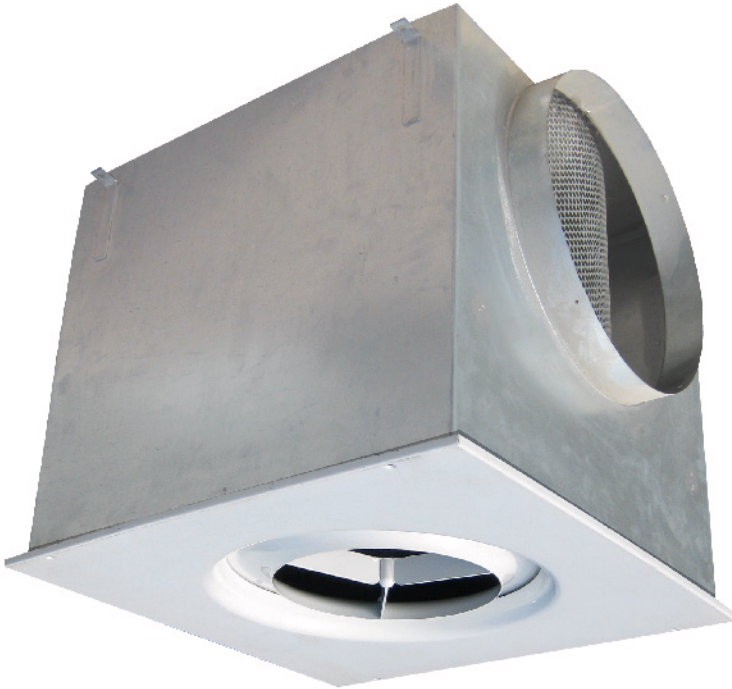

Swirl chamber diffuser

The WKD 381 diffuser has been specially developed to meet air requirements in areas with high ceilings. Its design allows for an installation in free suspension.

The WKD 381 is a high induction swirl diffuser with a round front plate, a turbulence chamber integrated in the plenum, and an adjustable nozzle.

The adjusting mechanisms of the WKD 381 with an adjustable nozzle facilitates the variation of the air jet direction (horizontal to vertical).

Regardless of the ventilation mode, heating or cooling, the WKD 381 is efficient in both industrial and commercial settings. The adjustment can be manual or motorized.

Areas of application

- Commercial spaces
- Theaters
- Exposition Centres
- Stores
- Industrial spaces
- Gymnasiums

Benefits

- Adjustable airflow
- Low acoustic power
- Rapid decrease of speeds and temperature differences
- Reduction of energy costs for air treatment
- Manual or motorized adjustment
- Possibility of changing the air jet penetration force by varying its intensity and induction
- The long-range nozzle allows high vertical penetration in heating mode

Configuration and mode of operation

Configuration

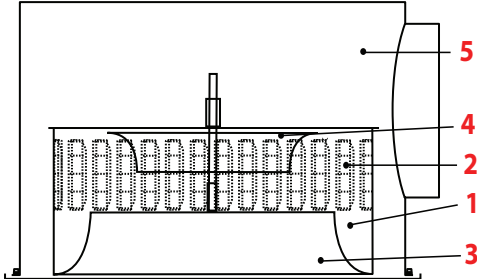

The WKD 381 diffuser is composed of a cylindrical swirl chamber (1), around which are placed eccentric rollers to direct air (2) to the deflector (3), and a manually or motorized adjustable long-range nozzle (4). These components are located in a plenum (5).

This diffuser is available in nominal sizes 300 / 500 / 600. It is adapted for heights up to 8 m (26 ft) and speeds up to 2000 m³/h (1176 pcm) per diffuser. The diffuser is powder coated with a polyester TGIC-free paint, providing a smooth, easy-to-clean, chip and fade resistant finish. The colours are available from the RAL colour chart.

Mode of operation

The air flow entering the turbulence chamber (1) through the eccentric rollers (2) creates an intensive helical movement, depending on positioning of the nozzle (4). The airflow at the deflector's outlet (3) will produce an induction and a variable penetration.

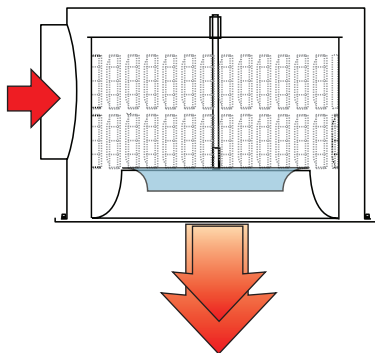
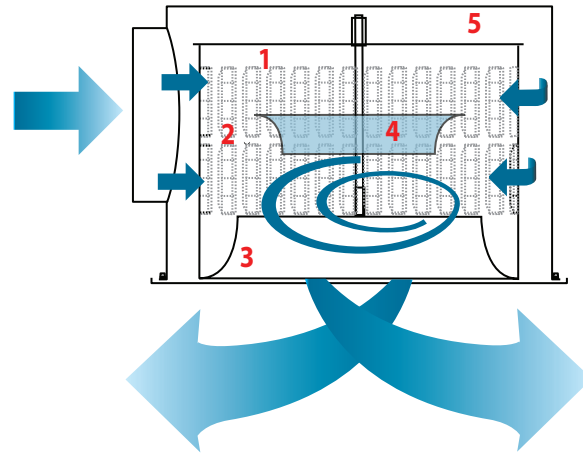

Heating

Nozzle Position 1
Stable vertical air flow with long penetration

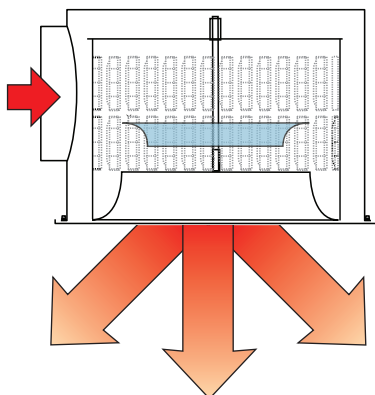

Nozzle Position 2
Vertical jet with helical effect

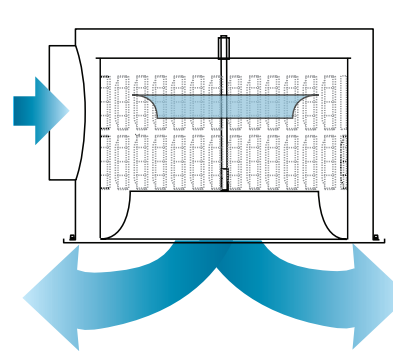

Cooling

Nozzle Position 3
Horizontal airflow with a reduced helical effect and a relatively low scope

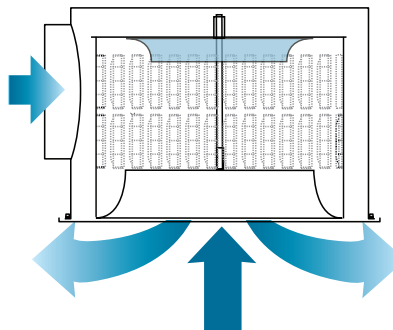

Nozzle Position 4
Horizontal airflow (without influence from the ceiling) with a maximum horizontal scope and an elevated primary induction

Range of application and quick selection

	L _{WA} (dB(A))	V ₀ (m ³ /h)	Δp (Pa)	Minimum space (m)	X _{crit} (m)	y (m)
DN 300 / 1	35	160	60	~2	1.3	7.0
	40	200	100	~2	1.7	9.0
	45	250	150	~2	2.0	11.0
DN 500 / 1	30	240	17	~2	1.3	3.0
	35	300	30	~2	1.7	3.7
	40	400	50	~2	2.2	5.0
DN 600 / 1	30	320	15	~2	1.1	2.8
	35	400	26	~2	1.4	3.6
	40	520	45	2	1.8	4.7
DN 600 / 2	30	500	15	2	1.7	4.5
	35	650	25	2	2.3	5.5
	40	850	45	2	3.0	7.7
DN 600 / 3	30	800	20	2	1.6	7.5
	35	1000	30	2	2.0	9.0
	40	1200	45	2	2.4	11.0

Specifications: The minimum space for an installation height to 3 m for an airflow speed in the occupied zone which will not exceed 0.2 m/s
The penetration length when in heating mode is ΔT = +10°C. The critical distance for ΔT = -8°C.

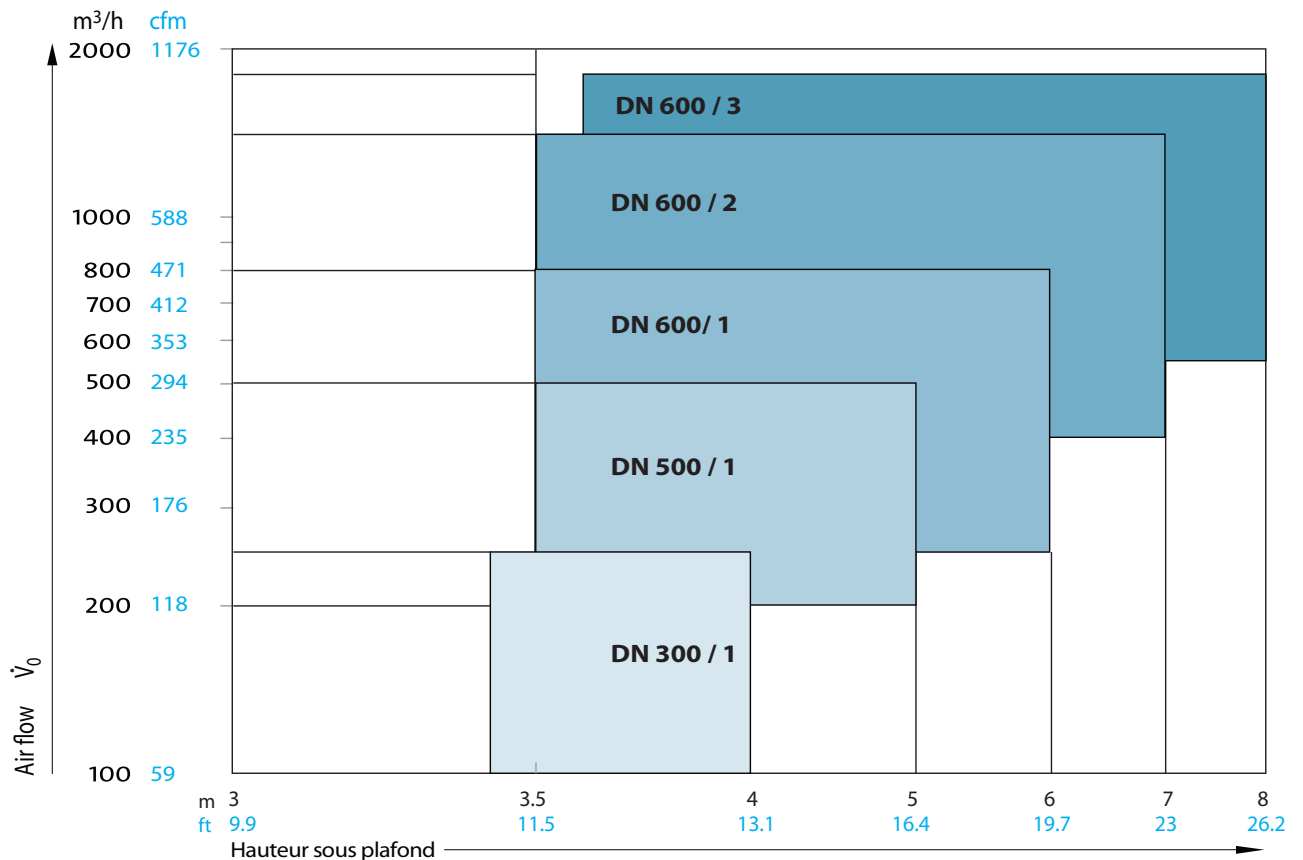

Performance diagrams

Ceiling airflow rating

Important:
 Acoustic absorption of the room is not accounted for.
 For a comparison with north american values, reduce the acoustic power by ten (10) dB.
 The values are based on an isothermal flow.

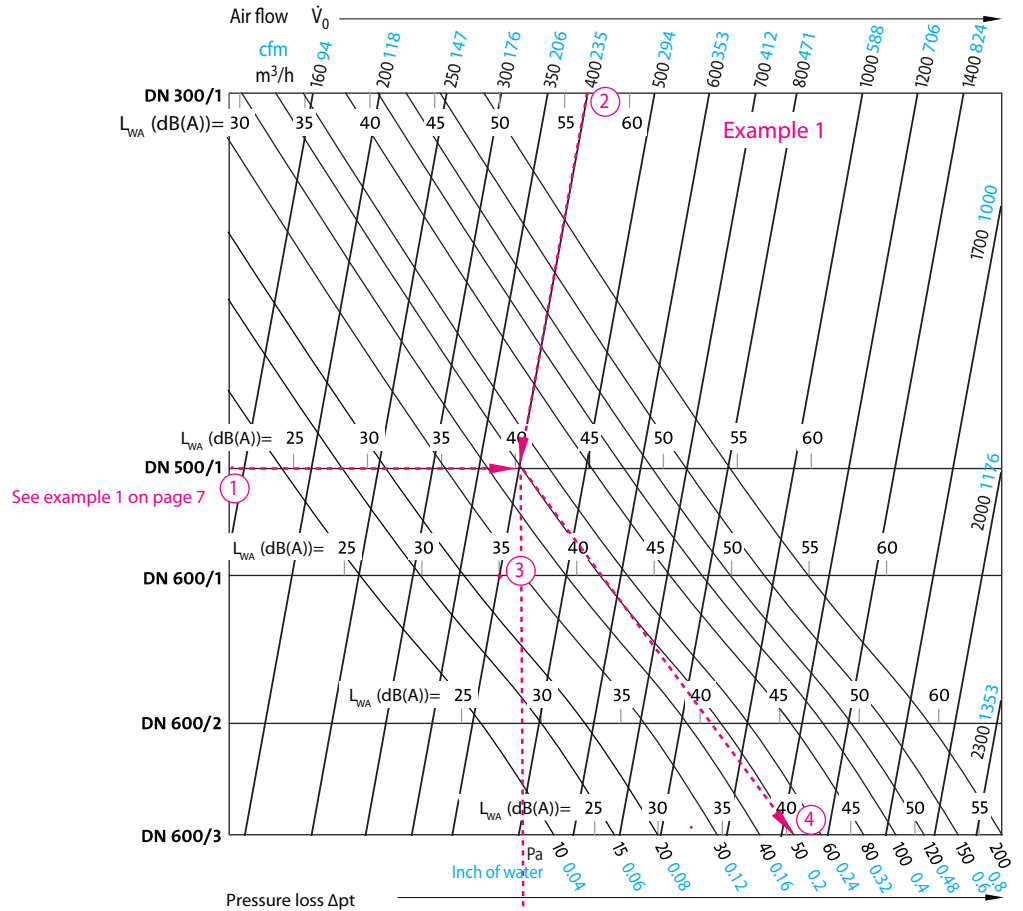

See example 1 on page 7

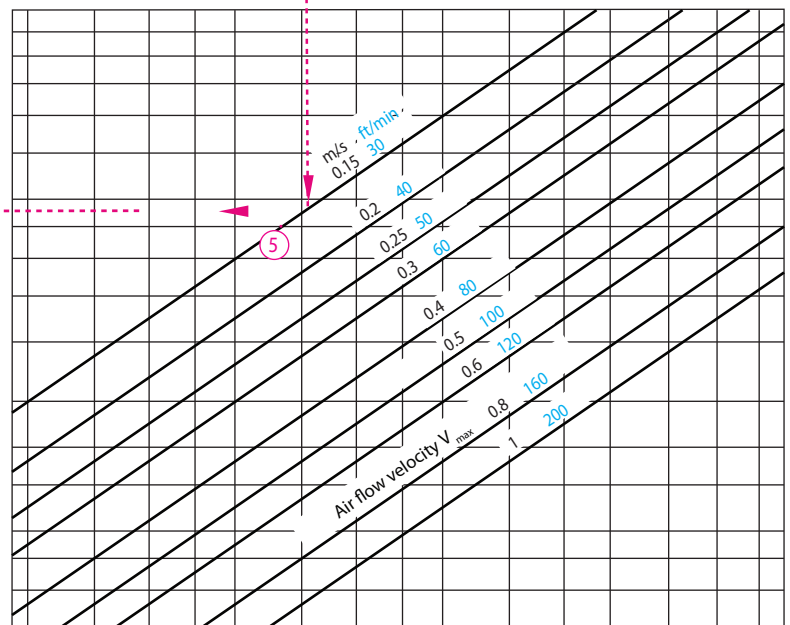
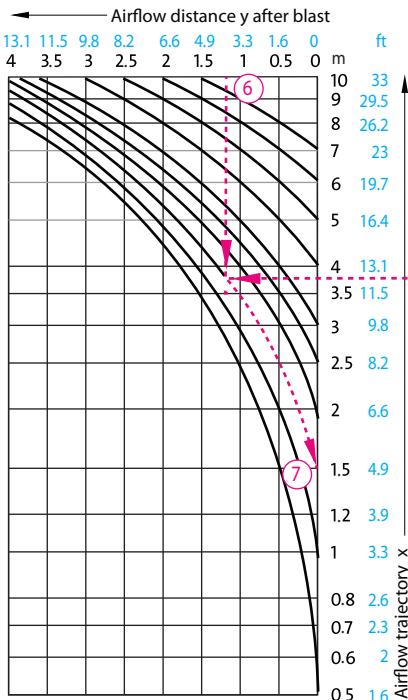

Performance diagrams

Vertical free airflow rating

Important:
Acoustic absorption of the room is not accounted for. For a comparison with north american values, reduce the acoustic power by ten (10) dB. The values are based on an isothermal flow.

See example 3 on page 7 ①

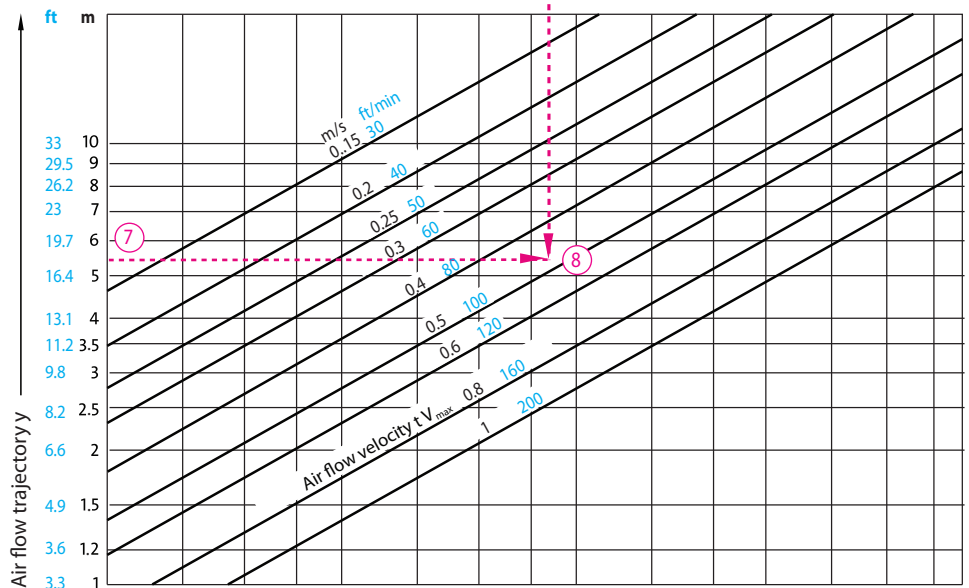
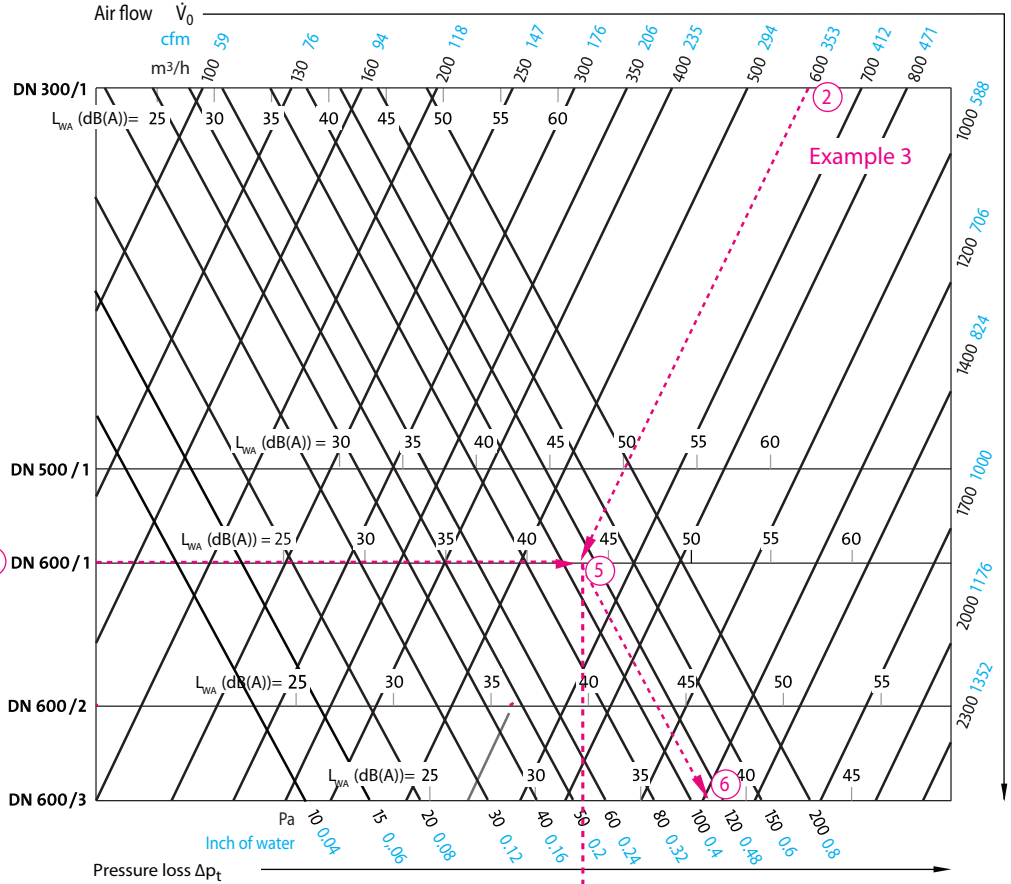

Performance diagrams

Critical airflow trajectories in cooling mode



DN 300 - 1

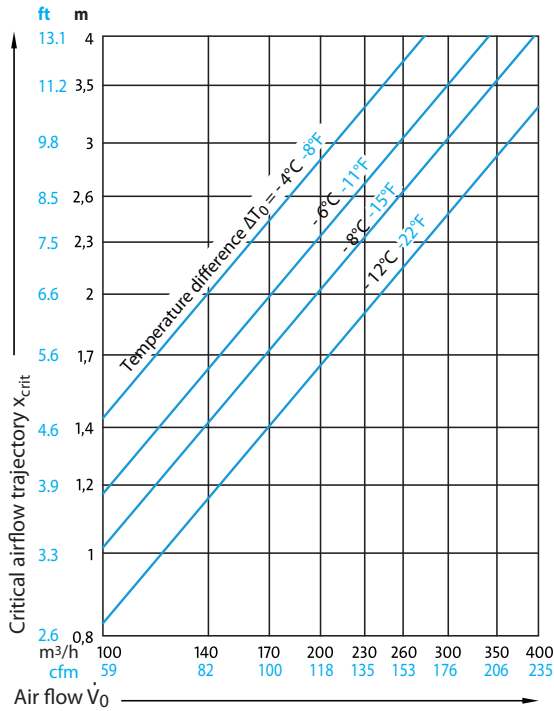

DN 500 - 1

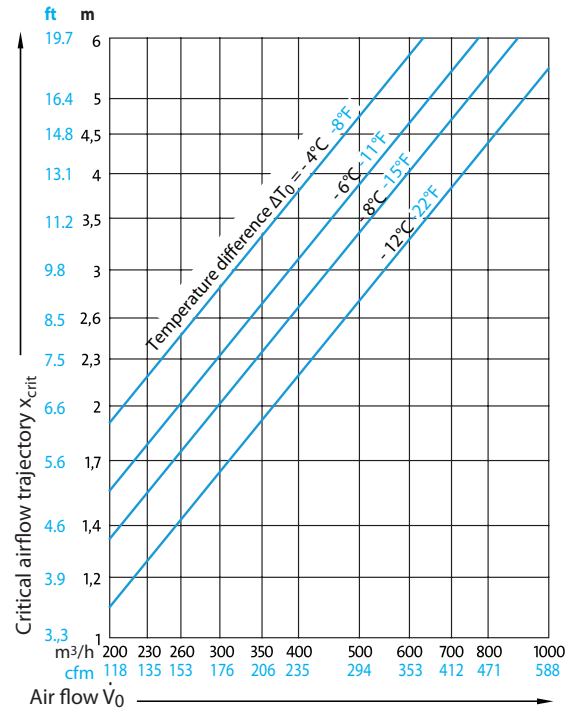

DN 600 - 1 / - 2

① See example 2 on page 7

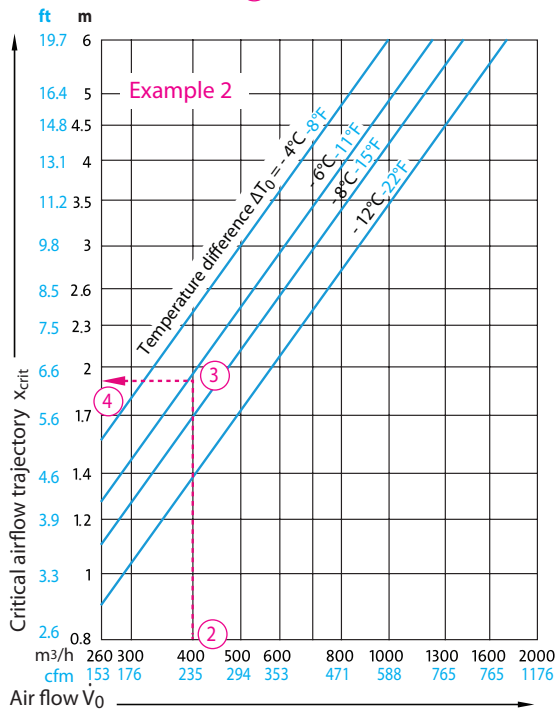

DN 600 - 3

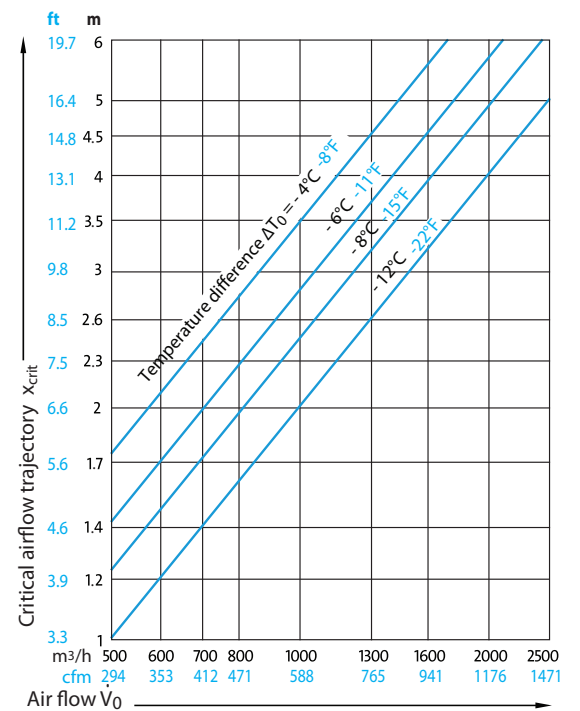

Performance diagrams

Vertical penetration in heating mode

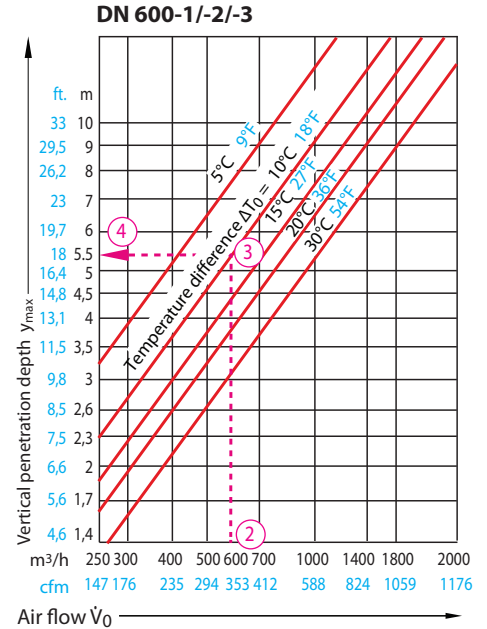
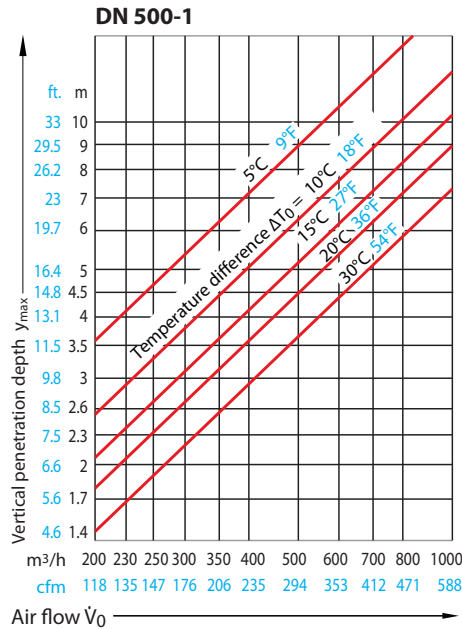
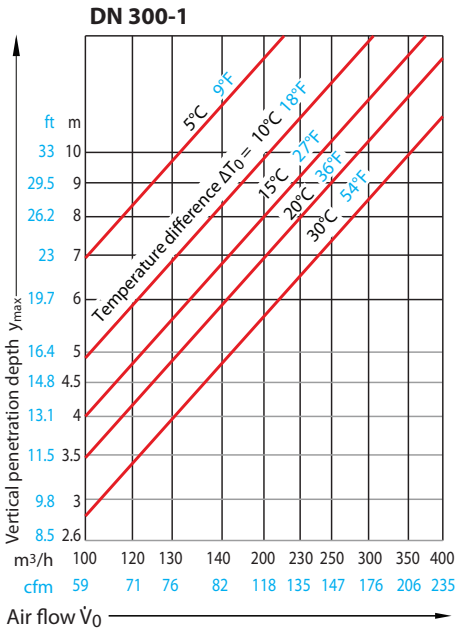

Example 1

Data

Height of the space: 3 m (10 ft)
 Maximum speed of the airflow at head height (1.8m): 0.15 m/s (5)
 Airflow \dot{V}_0 : 400 m³/h

Required

1. Dimension of the diffuser
2. Acoustic power L_{WA} , loss of pressure, distance between the diffusers.

Solution

- 1) From the "Areas of application" diagram we read the nominal dimension DN 500 / 1. (1)
- 2) From the "Horizontal air flow" diagram we follow the DN 500 - 1 and for an airflow of 400m³/h: (2)
 - a. Acoustic power: 60 dB(A) (3)
 - b. Total loss of pressure: 50 Pa (4)
 - c. For $y = h - 1.8 = 3.0 \text{ m} - 1.8 \text{ m} = 1.2 \text{ m}$ (6)

We deduce for $v=0.15 \text{ m/s}$ (5) a distance between diffusers of at least $2 \times 1.5 \text{ m} = 3 \text{ m}$. (7)

Example 2

Data

Nominal size: DN 600 - 1 (1)
 Air flow: 400 m³/h (2)
 Temperature difference: -6°C (3)

Required

Critical air flow trajectory

Solution

From the critical air flow trajectory we see:

$$x_{\text{crit}} = 1.9 \text{ m} \text{ (4)}$$

Example 3

Data

Air flow: 600 m³/h (2)
 Temperature difference: +10°C (3)

Research

1. Dimension of the diffuser
2. Vertical penetration depth in heating mode
3. Acoustic power L_{WA} and the total loss of pressure

Solution

1. From the "Areas of application" diagram we read the dimension DN 600 - 1 (1)
2. From the "Vertical penetration in heating mode" diagram we follow $y = 5.5 \text{ m}$ (4)
3. From the "Horizontal air flow" diagram we follow: acoustic power = 48 dB(A) (5)
 Total loss of pressure = 115 Pa (6)

Note:

If there is no modulation and the air is 100% vertical and isothermal to $y = 5.5$ (7) we read $V_{\text{MAX}} = 0.48 \text{ m/s}$. (8)

Temperature and induction behavior

Temperature behavior and the nozzle position's influence on the jet

Displacement flow

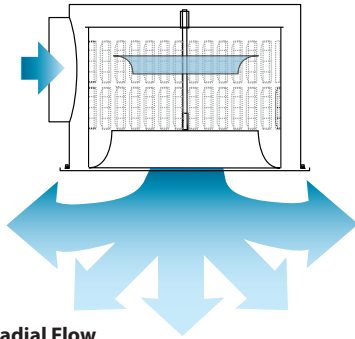

Axial - Radial Flow

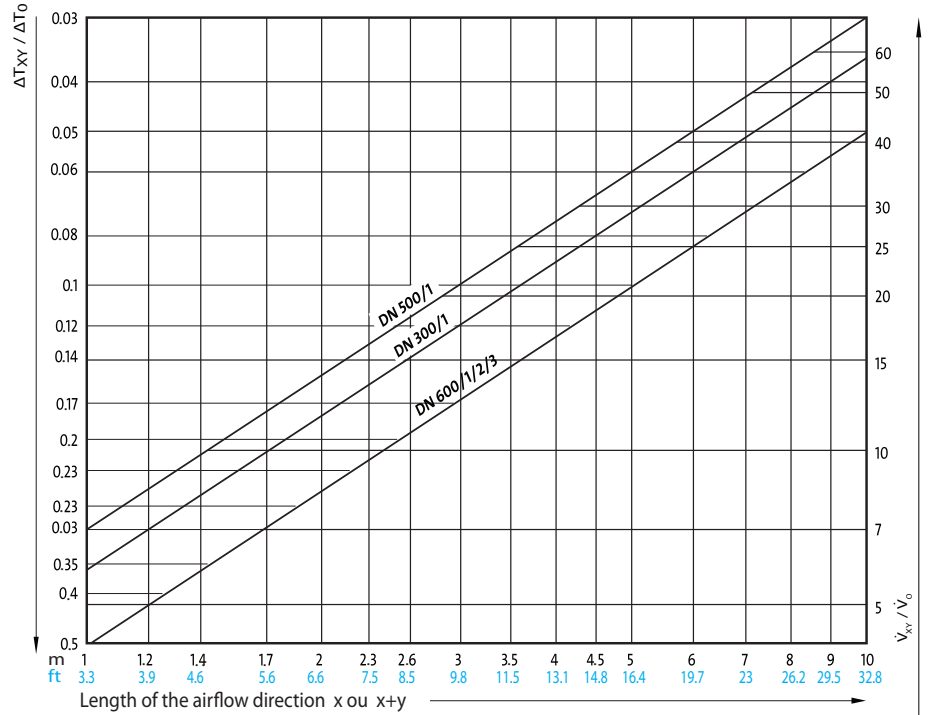
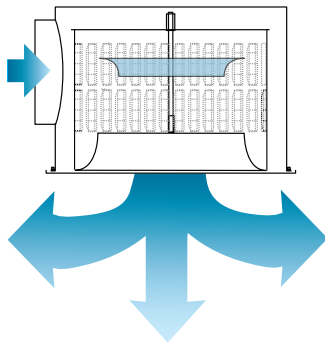

Dimensions and weight

WKD 381, side inlet

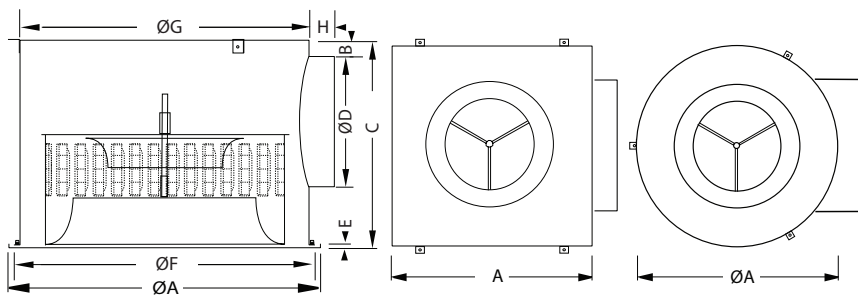

top inlet

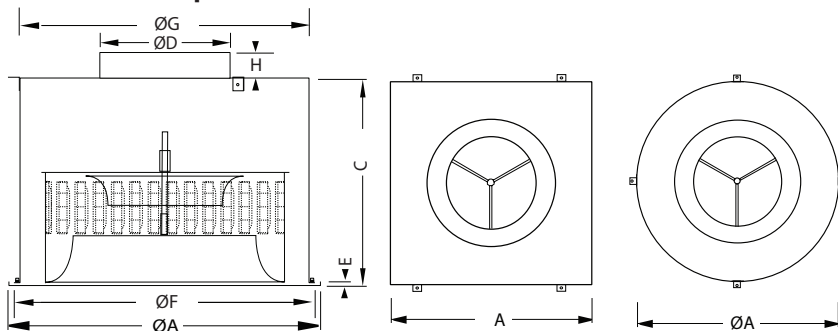

	300/1	500/1	600/1	600/2	600/3
Size A	300	502	603	603	603
Size ØA	300	502	600	600	600
Size B	33	33	33	33	33
Size C	403	403	403	503	603
Size ØD	150	200	250	350	400
Size E (Q)	12	12	12	12	12
Size E (R)	7	7	7	7	7
Size F	280	482	580	580	580
Size G	260	462	560	560	560
Size H	50	50	50	50	50
Weight (kg)	16,2	24,7	29,62	31,75	33,87

Q = square
R = round
Ø = diameter
= side of square

Specifications

1- Description and physical characteristics

- 1.1 The swirl air diffuser shall be made of steel. The square or round diffuser shall be equipped with an adjustable nozzle to guide the air flow.
- 1.2 The diffuser shall be equipped with a turbulence chamber composed of a round plate with vertically placed eccentric rollers.
- 1.3 The diffuser adjustment mechanism shall be available in manual and motorized modes.
- 1.4 The diffuser shall be powder coated with a polyester TGIC-free paint, providing a smooth, easy-to-clean, chip and fade resistant finish. The architect or client shall choose a standard colour from the RAL colour chart.

2 - Performance

The performance shall be guaranteed by using performance curves or simulation software for critical areas. These curve shall indicate the pressure drop, acoustic power generated as well as showing a cross-sectional view illustrating the critical airflow path in cooling, isothermal and heating modes. This critical airflow path shall have a rated speed at 1.8 m (6 ft) from the ground in occupied area or as requested by the engineer.

3 - Installation

The swirl diffuser shall be mounted on a galvanized steel plenum supplied by the manufacturer.

4 - Balancing

- 4.1 The diffuser balancing shall be executed by a ventilation system balancing technician holding a certificate of qualification.

5 - Quality Requirements: NAD Klima, model WKD 381

Codification

WKD 381	Product
Q = Square (DN 600 only) R = Round	Configuration
300, 500, 600	Nominal dimension
300, 502, 603, RND	Outer size
1 = 100 mm 2 = 200 mm (DN 600 only) 3 = 300 mm (DN 600 only)	Slot height
9003 = White 9010 = Cream 00SB = Solar Black (Standard matte black) 00SM = Silver Matte (Standard metallic grey) ____ = RAL color (write the RAL color number)	Diffuser color
T = Plenum with top inlet S = Plenum with side inlet	Plenum
H = Hand adjustment M = Motorized adjustment	Adjustment
WKD381 - Q - 300 - 300 - 1 - 9003 - T - H	Exemple

nad
K L I M A

www.nadklima.com

NAD Klima

144, rue Léger,
Sherbrooke, QC, J1L 1L9 Canada
819 780-0111 • 1 866 531-1739

info@nadklima.com

MADE IN

CANADA