

MSA

Ceiling diffuser
catalog 1.1.2





MSA

Table of contents

Description, areas of application and benefits	1
Configuration.....	2
Aerodynamic data and mode of operation	3
Air flow	4
Performance diagrams	5
Critical airflow distance on cooling mode	6
Dimensions and weight / Fireproof damper	7
Specifications	8
Codification	9

Presentation and benefits

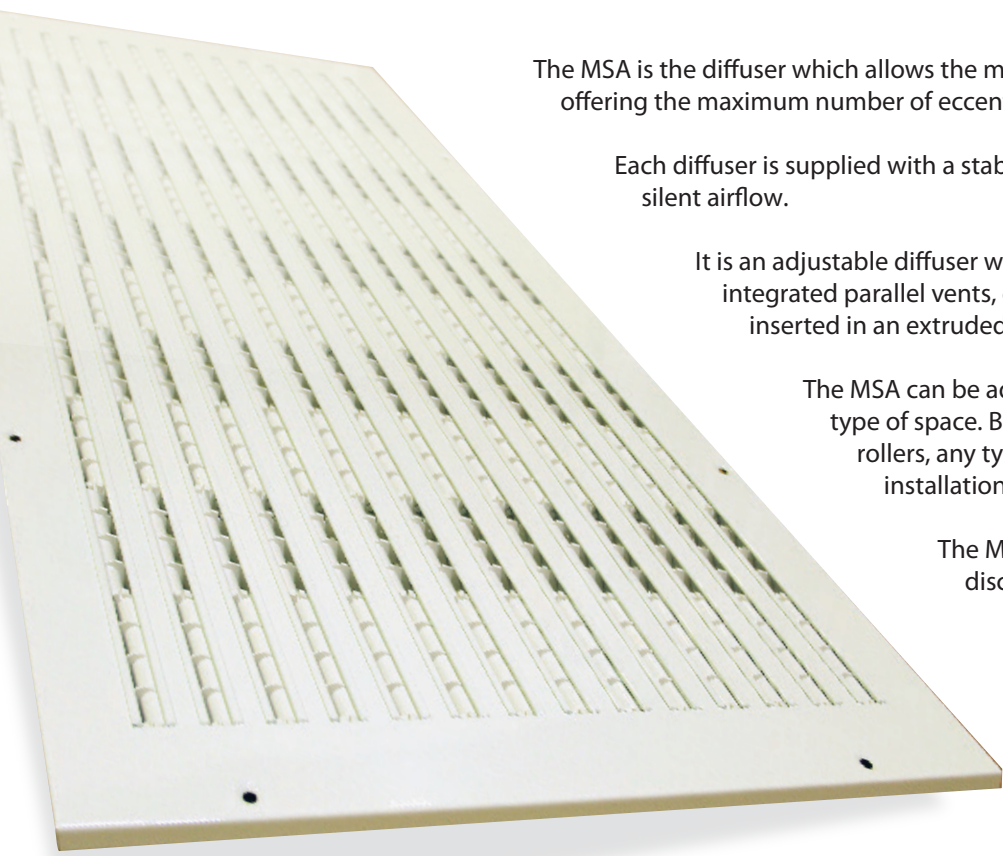

The MSA is the diffuser which allows the maximum air volume per area in its category, offering the maximum number of eccentric rollers possible.

Each diffuser is supplied with a stabilising chamber, allowing for a uniform and silent airflow.

It is an adjustable diffuser with a square or rectangular frontal plate and integrated parallel vents, composed of eccentric ABS rollers, which are inserted in an extruded aluminum profile.

The MSA can be adapted to optimize a ventilation system in any type of space. Because of the ability to adjust the eccentric rollers, any type of air flow can be obtained even after installation.

The MSA's technology provides high speed discharge of air with low acoustic power.

Areas of application

- High air flow areas (cuisine, etc.)
- Computer rooms
- Laboratories
- Theatres
- Conference rooms with high airflows
- Open plan offices

Benefits

- The largest volume of air per area
- Low acoustic power for a high airflow
- Possibility of changing the airflow even after installation
- Possibility of varying the speed of expelled air
- Rapid reduction of flow speed and temperature variations caused by high induction
- Eccentric rollers rotating up to 180°
- Possibility of reducing total airflow rate as much as 25% in VAV
- Approximately 3 times more induction than a conventional 4-way diffuser
- Approximately 3 times less temperature variation in occupied area than a traditional diffuser
- Adaptable to systems requiring constant or variable airflows

Configuration

Generally, whether on a square or rectangular plate, slots receiving the eccentric rollers are laid out in a parallel pattern.

The diffuser is mounted on a plenum.
The frontal plate is attached with screws distributed over the periphery of the frontal plate.

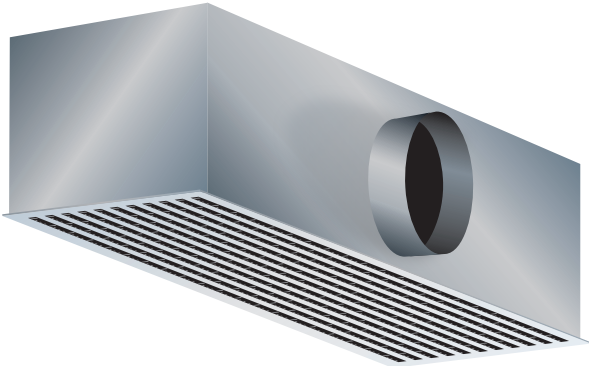

The diffuser is powder coated with a polyester TGIC-free paint, providing a smooth, easy-to-clean, chip and fade resistant finish. The colours are available from the RAL colour chart.

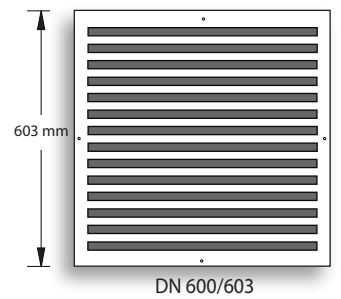
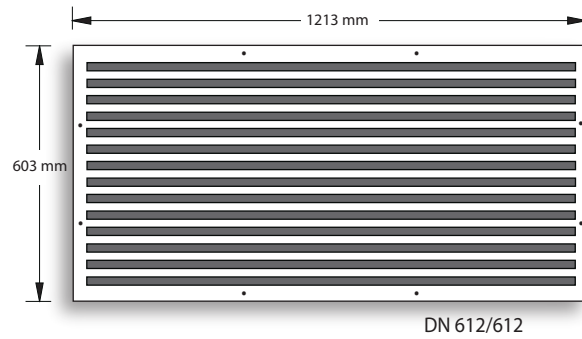
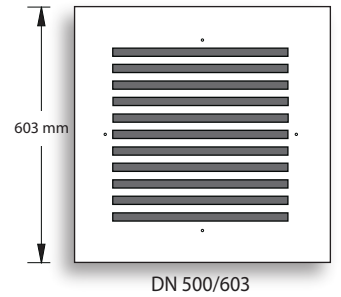
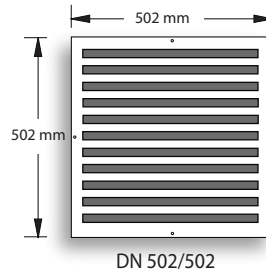
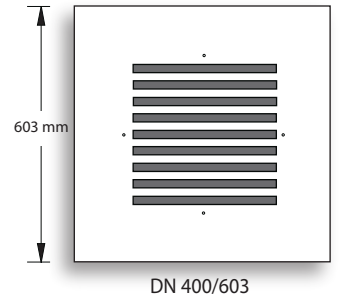
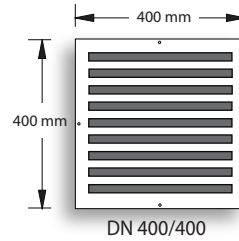
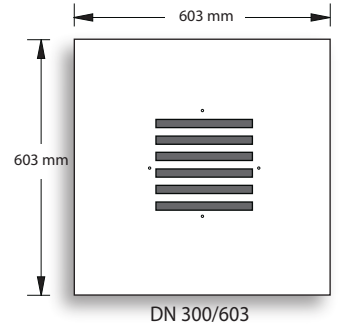
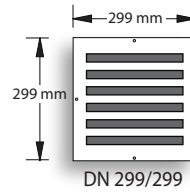

Mode of operation and aerodynamic data

Mode of operation

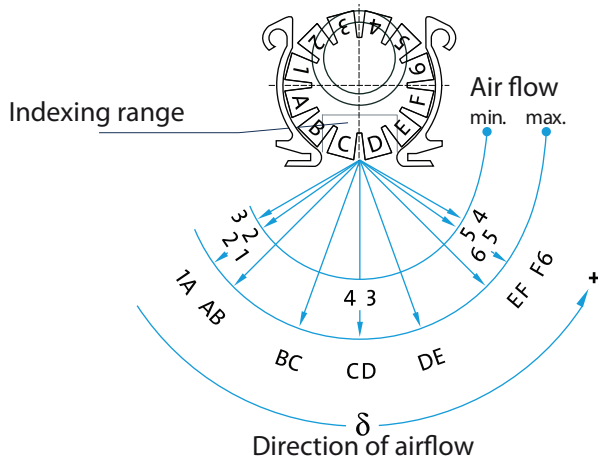

Controlling airflow direction

The 100 mm long eccentric rollers can be rotated 360 degrees. In standard position (21), the eccentric roller establish, through the profile of the slots, a streamline in which air is carried along. At the roller's outlet, a low pressure is created, generating a high rate of induction.

Aerodynamic data

	\dot{V}_0 m ³ /h	Minimum spacing (m)	ΔP Pa	L_{WA} dB(A)*	Noise criteria - NC dB**	X_{crit} m
DN 300	130	5.6	17	25	-	2.2
	155	7.0	25	30	15	2.9
	190	9.0	37	35	20	3.5
DN 400	190	5.2	10	25	-	1.9
	230	6.0	14	30	15	2.4
	270	9.0	20	35	20	2.9
DN 500	320	7.0	7	25	-	2.4
	400	8.0	10	30	-	2.6
	480	10.0	14	35	15	3.0
DN 600	450	7.0	6	25	-	1.6
	550	9.0	8	30	-	2.2
	680	11.0	12	35	17	2.8
DN 612	990	7.0	6	25	-	1.6
	1200	9.0	8	30	-	2.2
	1500	11.0	12	35	15	2.8

* The absorption of the room is not considered.

** Determined by considering a room absorption of 10 dB.

Specifications : Minimum spacing of up to 3 m, so the flow does not exceed 0.15 m/s (30 fpm) at 1.3 m above the floor.

Roller position 1A

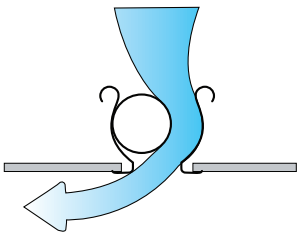

Roller position 21

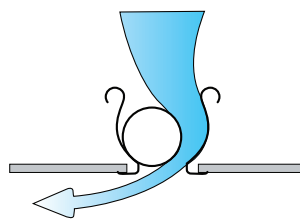

Roller position 43

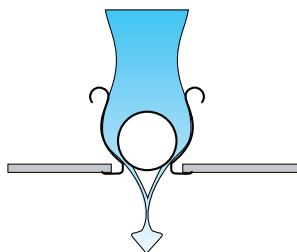

Roller position CD

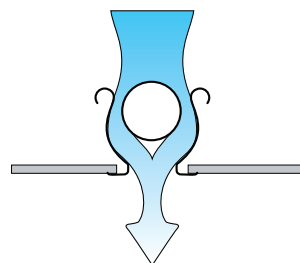

Air flow

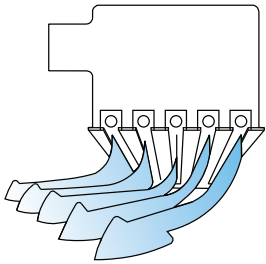

Flow on one side (DVD)

A dispersal of the jet on one side (left or right) is obtained by turning all eccentric rollers to position 21 or 65.

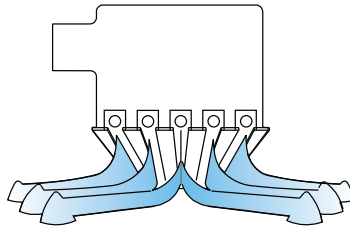

Divergent flow (DVS)

If all rollers on one half of the frontal plate are set to position 21 and the other half in position 65, the airflow obtained will be separated into two opposite airflows.

This setting is especially appropriate for spaces with high ceilings and areas with high air conditioning needs.

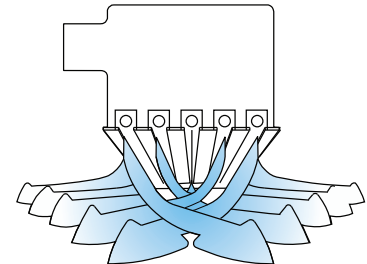

Diffuse flow (DFS)

The jets blow in two (2) opposite directions. The eccentric rollers' position, in slot length direction, will be adjusted alternately to 21 and 65.

It results in a strong induction of ambient air with a small drop in range. This is ideal for areas with low ceilings.

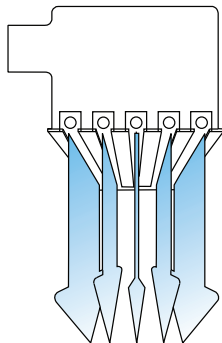

Vertical flow (DVV)

Positioning the rollers on CD will create a vertical airflow induction. The square shape of the diffuser causes the airflow to take a rectangular shape when it leaves the vent and can achieve a long range.

This type of air movement adapts well to large airflows and ceiling with heights up to 5 m.

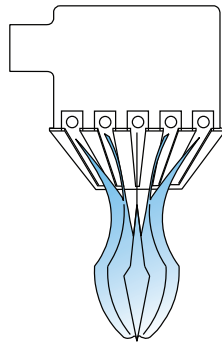

Vertical flow - long reaching (DVL)

Rollers in the central slots can be orientated in a vertical projection (CD), setting against the others in positions 1A and F6. This forms two (2) horizontal airflows meeting in the middle of the diffuser, directing downwards. The restriction of airflow prevents an induction of ambient air.

This configuration is particularly adapted for high airflows in heating mode and ceiling heights up to 7 m high.

Performance diagrams
Horizontal airflow below the ceiling

The velocities are given for the setting "Flow diffuse (DFS)".
For setting "Flow divergent (DVS)", apply the factor x 1.7.
For setting "Flow on one side", apply the factor X 2.0.

Attention:

The NC noise criteria and the acoustic power L_{WA} are determined by considering a room absorption of 10 dB.

Graph values are based on an isothermal flow.

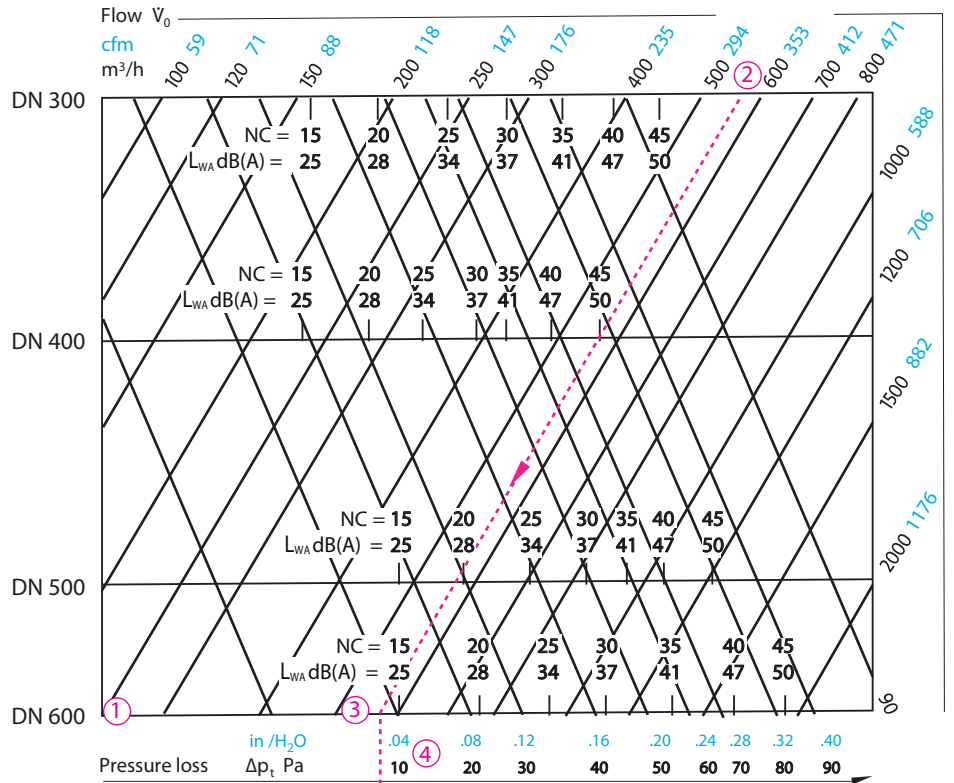

See example on page 6

DN 612 - Divide the total airflow by 2, and use the DN 600 diagram values.

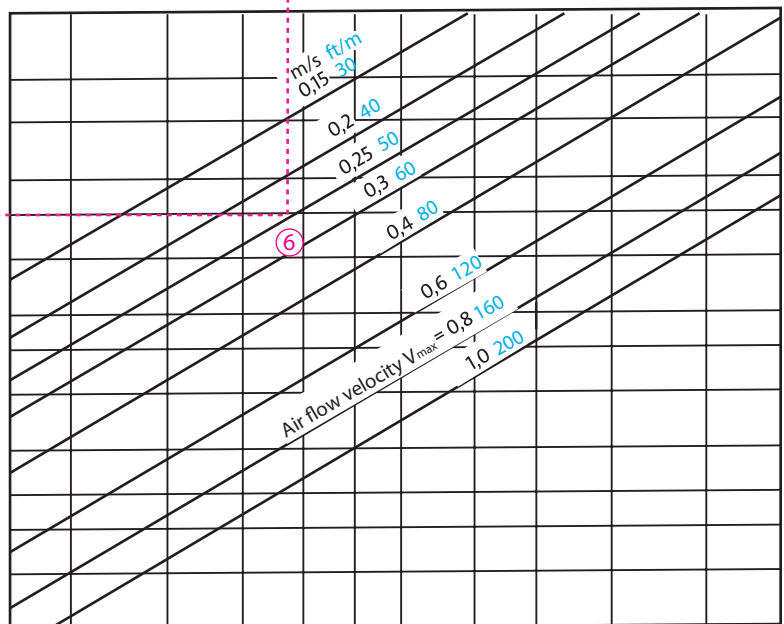
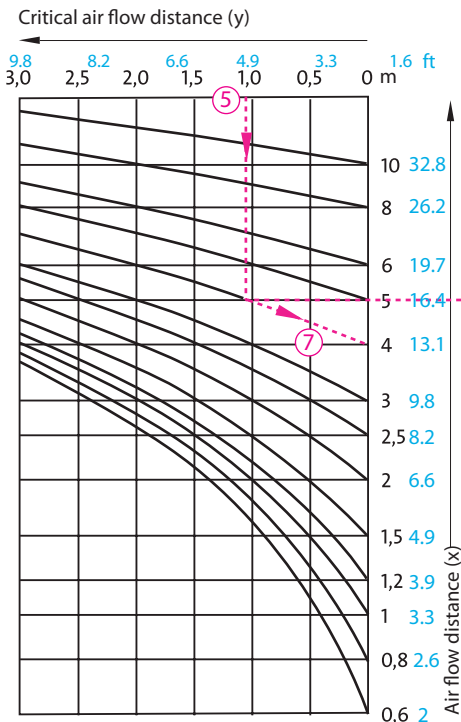

Critical airflow distance in cooling

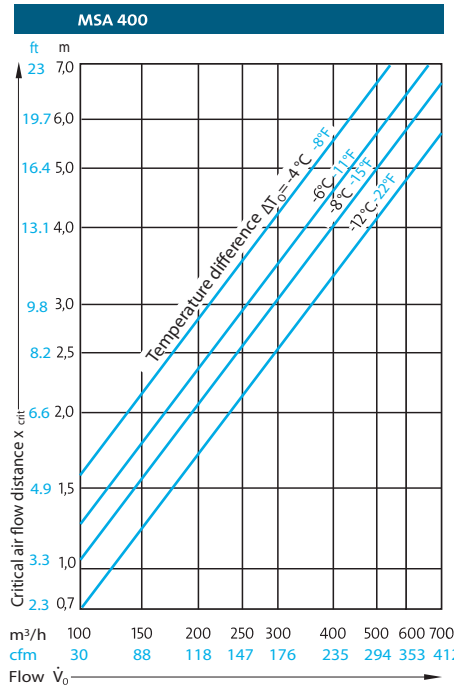
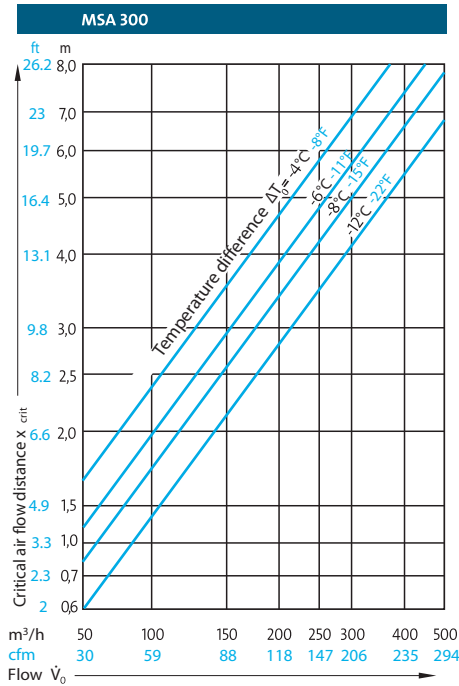

Speed data is for the setting "Airflow diffused below the ceiling" diffuse 21/65.

For the "Divergent airflows below the ceiling" it is necessary to apply a factor of X 1.7. For the "Airflow below the ceiling on the side" it is necessary to apply the factor X 2.0.

Specifications:

- Height of the area: $H = 3.0\text{ m}$
- Air flow/diffuser: $\dot{V}_0 = 580\text{ m}^3/\text{h}$
- Max. cooling: $\Delta T_0 = -10^\circ\text{C}$
- Max. air speed at height of 1.8 m: $\dot{V}_{max} = 0.25\text{ m/s}$
- Dimension of the diffuser: DN 600 ①

Required:

1. Noise criteria and acoustic power L_{WA}
2. Loss of pressure
3. Minimum distance between two (2) diffusers
4. Critical trajectory of airflow (airflow displacement at the ceiling when cooled)

Solution:

1. For the DN 600 diffuser, the airflow is $580\text{ m}^3/\text{h}$ ②
Noise criteria (NC) and acoustic power $L_{WA} = 23\text{ dB}$ ③
2. Loss of pressure: 8 Pa ④
3. For $y = H - 1.80 = 3.0\text{ m} - 1.8\text{ m} = 1.20\text{ m}$ ⑤ and a speed of 0.25 m/s ⑥ we find the minimum difference of 4 m . ⑦
4. The diagram "critical trajectory of air while cooling" for a DN 600, an airflow of $580\text{ m}^3/\text{h}$ and a temperature reduction of 10°C ⑧ we obtain a critical trajectory of airflow of 2.2 m . ⑨

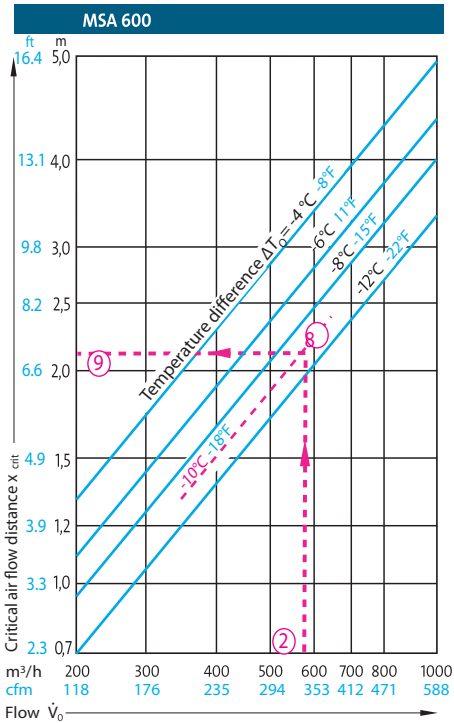
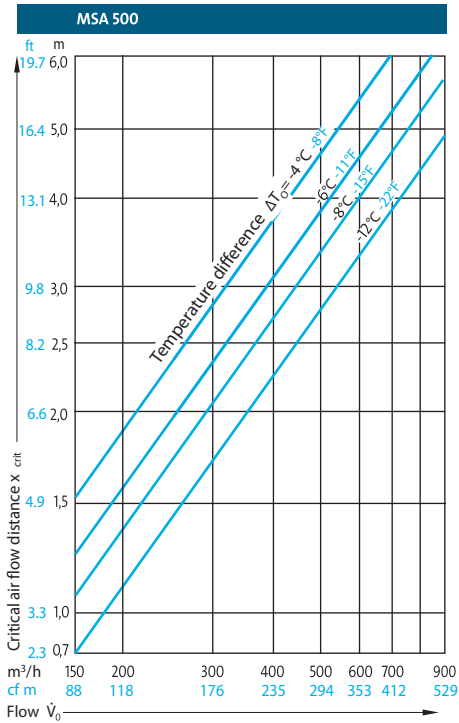

Dimensions and weight

Regular plenum

DN	300	400	500	600	612*
Size A	299	400	502	603	603/1213
Size B	75	75	82	40	50
Size C	251	251	312	364	418
Size ØD	150	150	200	300	350
Size F	296	399	490	590	590/1195
No. slots	6	9	11	14	14
Weight (kg)	4.6	5.6	8.6	12.2	27.4

Side inlet

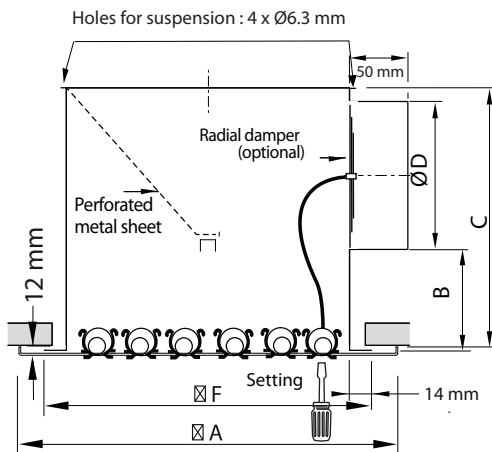

Top inlet

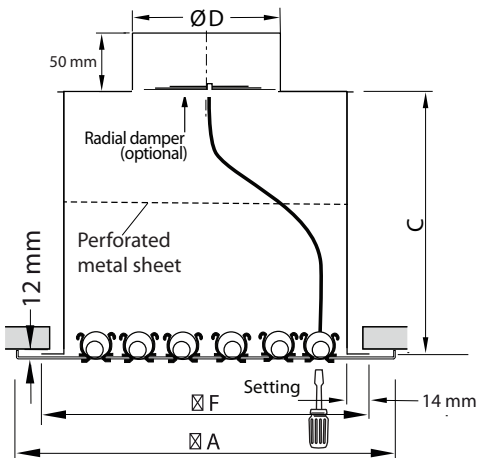

*The dimensions are determined with an installation in a suspended ceiling (603 x 1213).

Plenum with fireproof damper

DN	600	612*
Size A	603	603/1213
Size B	40	50
Size C	515	569
Size ØD	300	350
Size F	590	590/1195
No. slots	14	14
Weight (kg)	20.2	40.4

Note: The balancing damper is not available with fireproof damper.

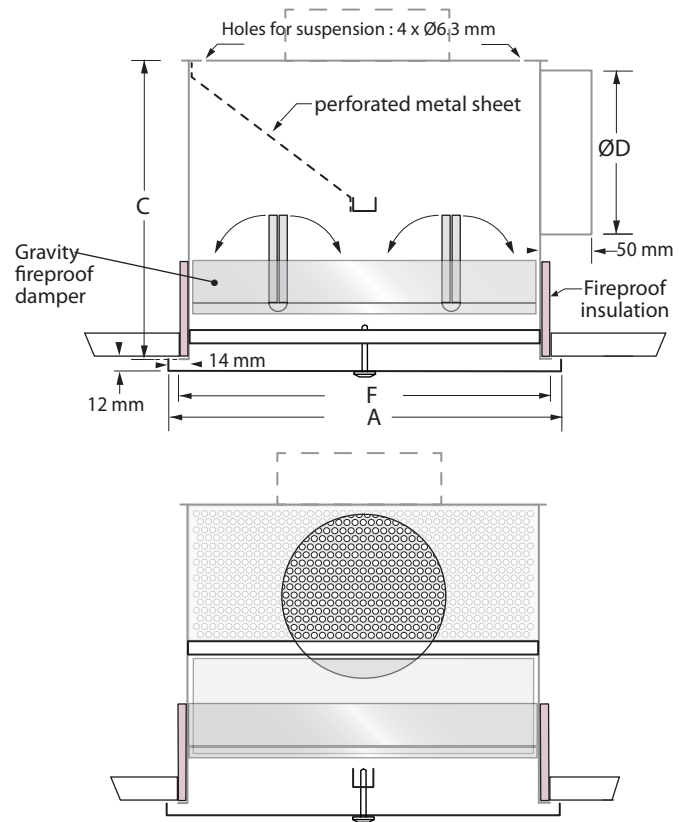

Classified ULC (Underwriters' Laboratories of Canada), the NAD Klima fireproof damper has a flame retardant factor of (3) hours. The fireproof damper is directly integrated to the plenum for sub gypsum and suspended ceiling installations.



LISTED
Air Terminal Unit - R38924
CAN/ULC - S112.2 et CAN/ULC - S101



CLASSIFIED
CEILING AIR DIFFUSER
FIRE RESISTANCE CLASSIFICATION
ANSI/UL 555C et ANSI/UL 263

Specification

1. Description and physical characteristics

1.1 The high induction swirl airflow diffuser shall be made of 20 ga. galvanized steel. The square or rectangular front plate shall have integrated, adjustable eccentric rollers.

1.2 The 100 mm long eccentric rollers shall be alphanumerically identified which will enable an adjustment of air flow pattern over 180 degrees.

1.3 The diffuser's front plate shall be adapted to fit regular North American suspended ceilings or classic gypsum ceilings.

1.4 The diffuser plate shall be available for air flows of 1, 2 or 3 directional configurations as well as corner or "L" shapes.

1.5 The diffuser shall be powder coated with a polyester TGIC-free paint, providing a smooth, easy-to-clean, chip and fade resistant finish. The architect or client shall choose a standard colour from the RAL colour chart.

2. Performance

2.1 The performance shall be guaranteed by using performance curves or simulation software for critical areas. These curves shall indicate the pressure drop, acoustic power generated as well as showing a cross-sectional view illustrating the critical airflow path in cooling, isothermal and heating modes.

2.2 Parameters of guaranteed comfort

2.2.1 The performance statistics of the diffuser shall reflect a maximum air speed of 0.15 m/s (30 ft/m) in occupied zone at 1.3 m (4 ft) from the floor. The performance guarantee shall be demonstrated in plan view with circles showing the air stream path.

2.2.2 The diffuser shall ensure a maximum variance in temperature of -1°C between the air jet and the area occupied at 4 ft (1.3 m) from the floor. To achieve this, the ratio of temperature differential shall perform at a minimum of $\Delta T_{xy} / \Delta T_0 \leq 0.1$ (for an initial differential of $\Delta T_0 = -10^\circ\text{C}$).

2.2.3 In cooling, the diffuser shall guarantee, in variable volume (VAV), a critical distance (X_{crit}) of at least the value indicated in the following table:

Diffuser inlet (in)	6	8	10	12
Air flow max. (pcm)	80-150	151-280	281-400	401-600
min. (pcm)	20-40	41-90	91-140	141-200
X critical - ft	1'- 7"	1'- 11"	2'- 3"	2'-7"
(m)	0.5	0.6	0.7	0.8

3. Plenum

3.1 The diffuser shall be delivered with a plenum made and tagged by the diffuser's manufacturer. The plenum shall be constructed from 24 gauge galvanized steel and include a perforated stabilizing (equalizing) plate, which regulates the airflow rate. Four suspension points, adhering to paraseismic standards, shall be integrated in the plenum. The inlet shall be centered on the side or on the top of the plenum, and its size shall be calibrated to accommodate the airflow rate. The joints of the plenum shall be sealed with VOC (volatile organic compounds) emission-free caulking.

3.2 The frontal plate shall be attached with screws distributed over the periphery of the frontal plate.

3.3 When required, the plenum shall be supplied with a damper adjustable through the finished side of the front plate, in order to adjust air volume.

3.3.1 **Radial damper:** Key with circular pivoting blades on a flexible metallic cable, which shall be adjustable through the front plate of the diffuser, allowing for an air flow adjustment from 0% to 100%.

4. Balancing

4.1 Balancing of MSA diffusers shall be performed by a professionally certified technician, trained in ventilation system balancing.

4.2 The technician shall take into consideration the correction factor of air volume using a balometer.

5. Quality required: NAD Klima model MSA



MSA

Codification

MSA	Product
300, 400, 500, 600, 612 (600 X 1200)	Nominal dimension
299, 400, 502, 603, 612 (603 X 1213)	Outer size
DFS = Standard diffuse 21/56 DFF = Diffuse height AB / EF DVV = Vertical divergence CD DVL = Vertical flow - long reaching 1A - CD - F6 DVD = Divergence 65 DVB = Divergence 21 DRB = Divergence with nozzles (return)	Air flow formation
W = White rollers (RAL 9003) C = Cream rollers (RAL 9010) B = Black rollers	Roller color
9003 = White 9010 = Cream White 00SB = Solar Black (Standard matte black) 00SM = Silver Matte (Standard metallic grey) _____ = RAL color (write RAL color number)	Diffuser color
S = Plenum with side inlet T = Plenum with top inlet X = Without plenum	Plenum
I = With acoustic insulation A = With closed cell acoustic insulation X = Without insulation	Acoustic insulation
F = With fireproof insulation et fire-proof damper (balancing damper not available) X = Without fireproof insulation et fire-proof damper	Fireproof insulation
R = With radial damper* X = Without damper	Balancing Damper
MSA - 300 - 299 - DFS - W - 9003 - S - X - X - X	Example

Notes:

Blue: Standard

*Not available for oval inlet

nad
K L I M A

www.nadklima.com

NAD Klima

144, rue Léger,
Sherbrooke, QC, J1L 1L9 Canada
819 780-0111 • 1 866 531-1739

info@nadklima.com

MADE IN

CANADA